

Non-Contact Infrared Temperature

4-IRman



GASDNA Co.,Ltd 101, Bukhang-ro 193beon-gil, Seo-gu, Incheon, 22856, Republic of Korea
Tell: +82-32-584-7420 Fax: +82-32-584-7424 E-mail: sales@gasdna.com Web: www.gasdna.com

<http://www.gasdna.com>

Product Features

The DAE-IRT-001, non-contact infrared thermometer, measures the quantity of infrared energy emitted from the object, followed by output to external area by converting standard signal (4 ~ 20mA), either, RS-485 communication signal simultaneously.

Also, it provides relay contact output by alarm signal.

Laser ON / OFF control is available with an external laser control signal

DAE-IRT-001 is composed of infrared sensor part and signal processing module, which can be measurable in the field at real-time basis.

The temperature measurement range of the object can be made from -60 degrees up to 380 degrees and can also be adjusted.

It has a high measurement accuracy with adoption of optical lens and the object in a far distance can be accurately measured with an optical resolution of 12: 1

The emissivity can be adjusted to 0.10 to 1.00

* Application field

Plastic, fluid, rubber, coating parts, paper, asphalt, ceramics, wood fabrics, glass, food, and etc.

Product Specification

Segment	DAE-IRT-001
Measured range	-60~380℃
Detection method	Thermopile
Accuracy	±0.5℃(Based on Black body)
Repeatability	±1% out of measurement
Optical resolution (D: S)	12:1
Optical Spectrum Wavelength	8~14μm
Response time	Less than 100msec
Emissivity	0.10~1.00
Analog output	4~20mA
Communications output	RS-485 Communications
Relay output	1 step- Relay Contact (AL-1)
Power	DC 20~30V(Max 200mA)
Ambient temperature compensation	0~80℃
Temperature resolution	0.1℃
Relative humidity	5~90%
Storage temperature	-30~85℃
Waterproof rating of detector	IP65
Laser pointer	630~670nm(red)
Size	Body Control: 98 × 64 / Sensing Head: 34 × 32
Correction	-9.99~9.99
Gradient	0.000 ~ 2.000
Weight	285 g
Cable length	3m,other

1. Electronics Housing

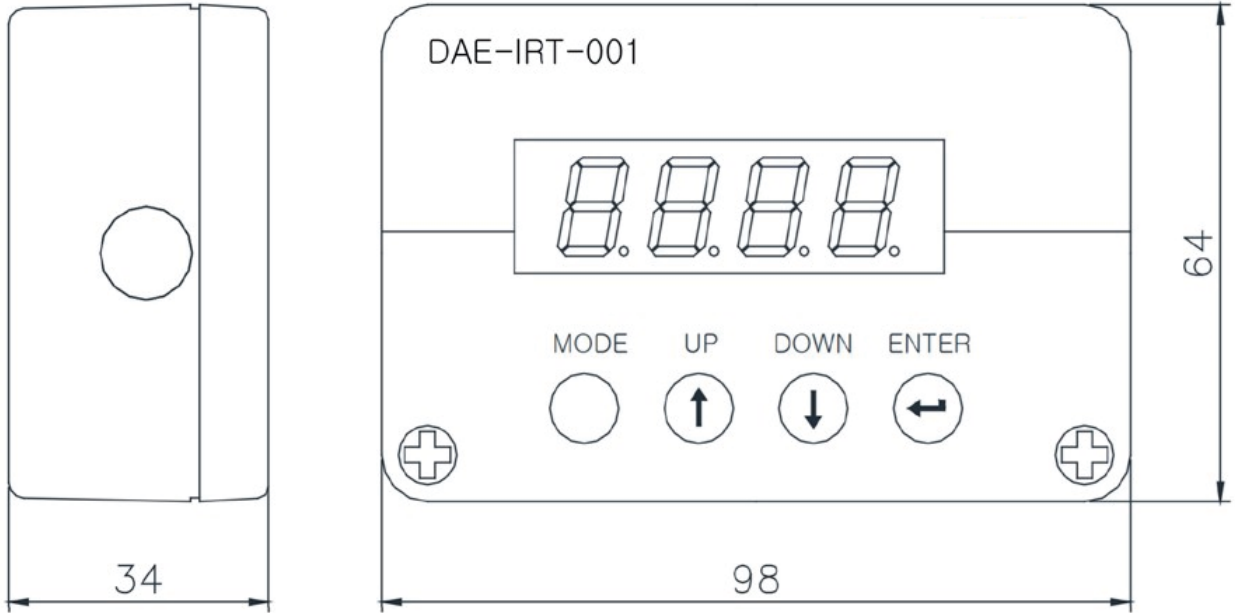

2. Sensing Head

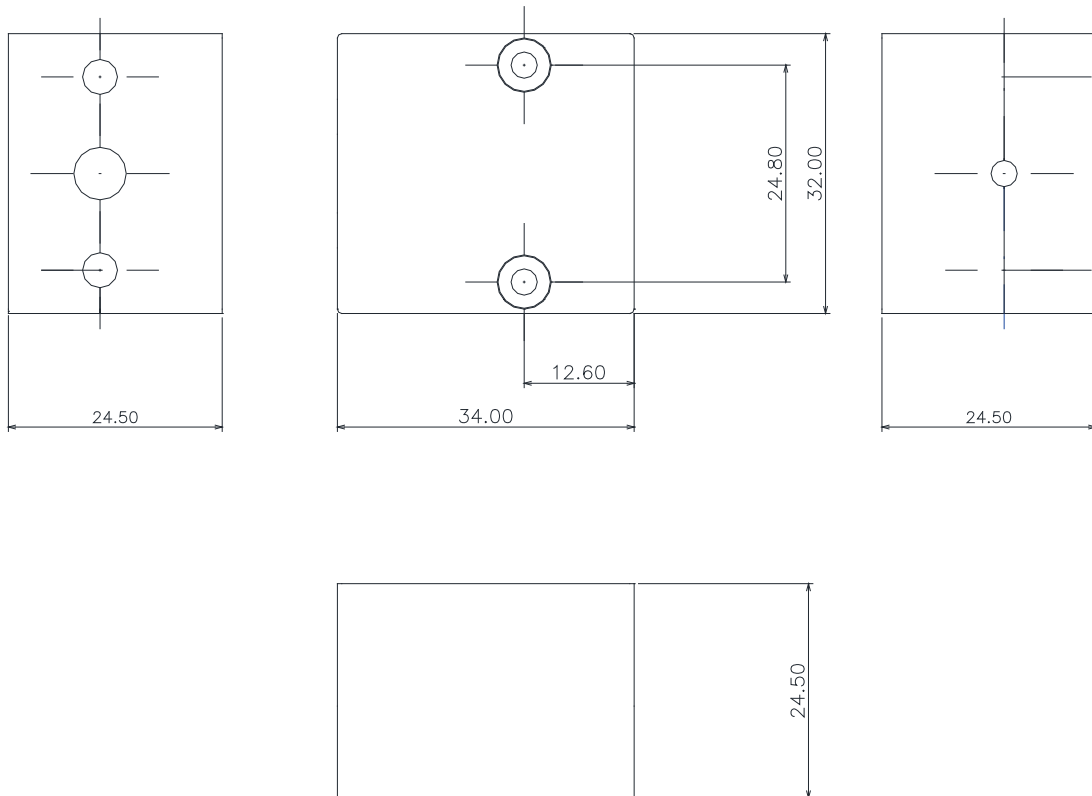

Wiring and Terminal Description

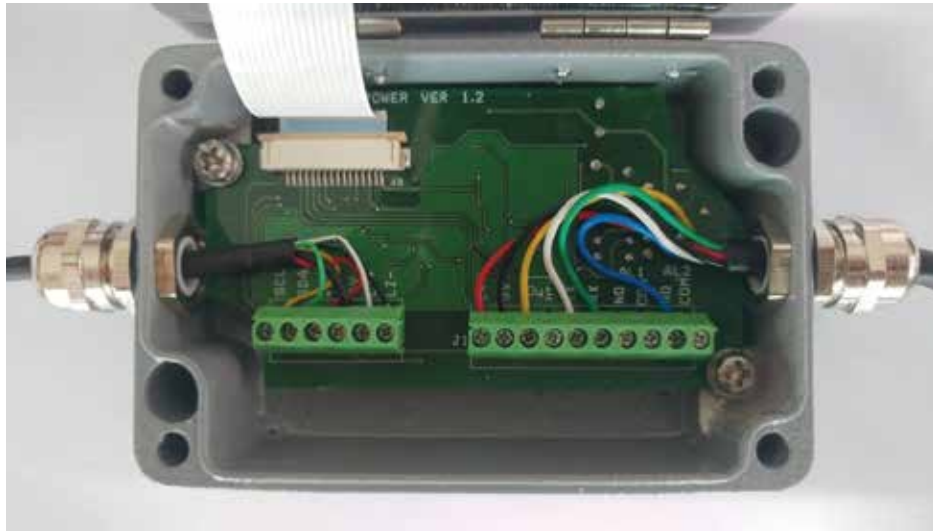
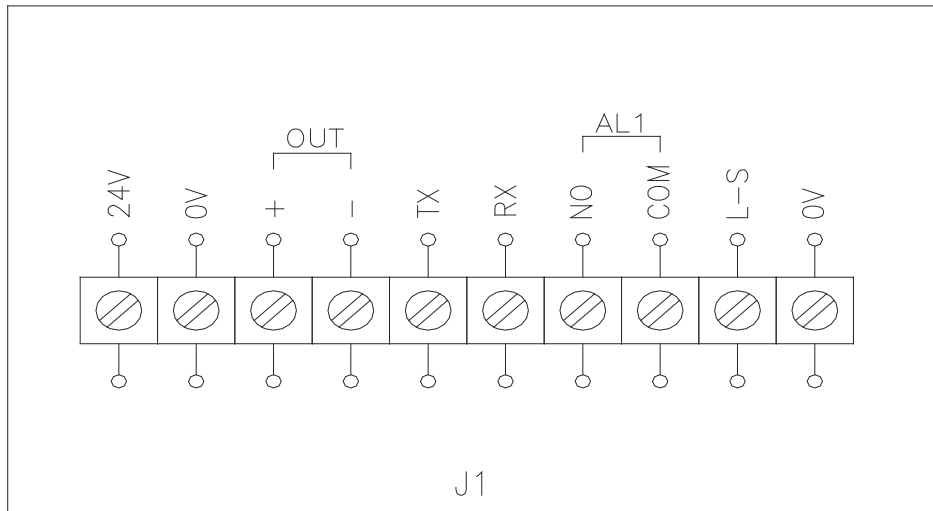

NO	라벨	선 색깔	용도
1	P24	RED	POWER (+24V)
2	N24	BLACK	POWER (0V)
3	MA	YELLOW	4-20 mA(+)
4	TX+	WHITE	RS485 A
5	TX	GREEN	RS485 B
6	SW-G	BLUE	Laser on (Laser on : 0V connect) (Laser off:OPEN)

Optical Chart(DS 12:1)

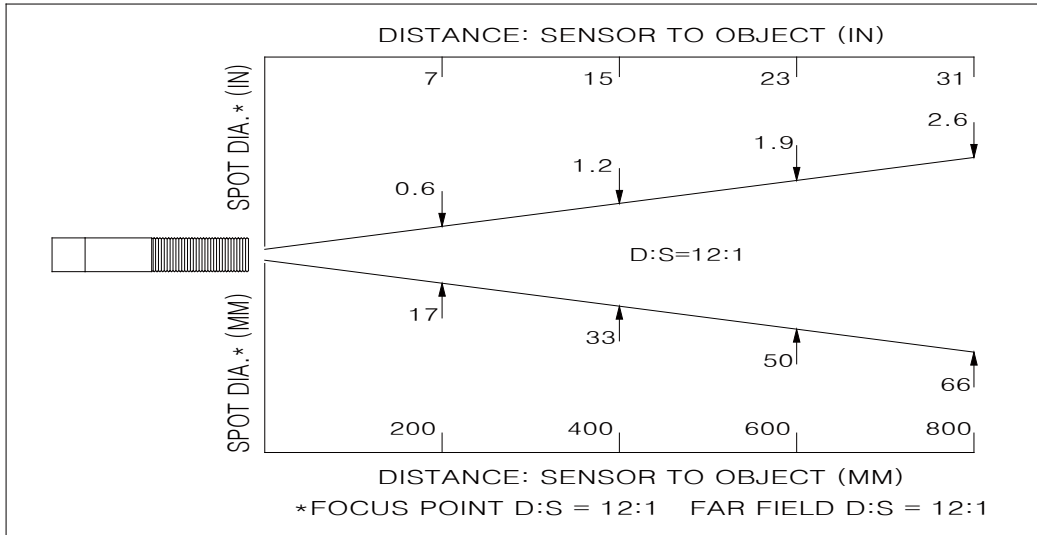

Product Composition and Name

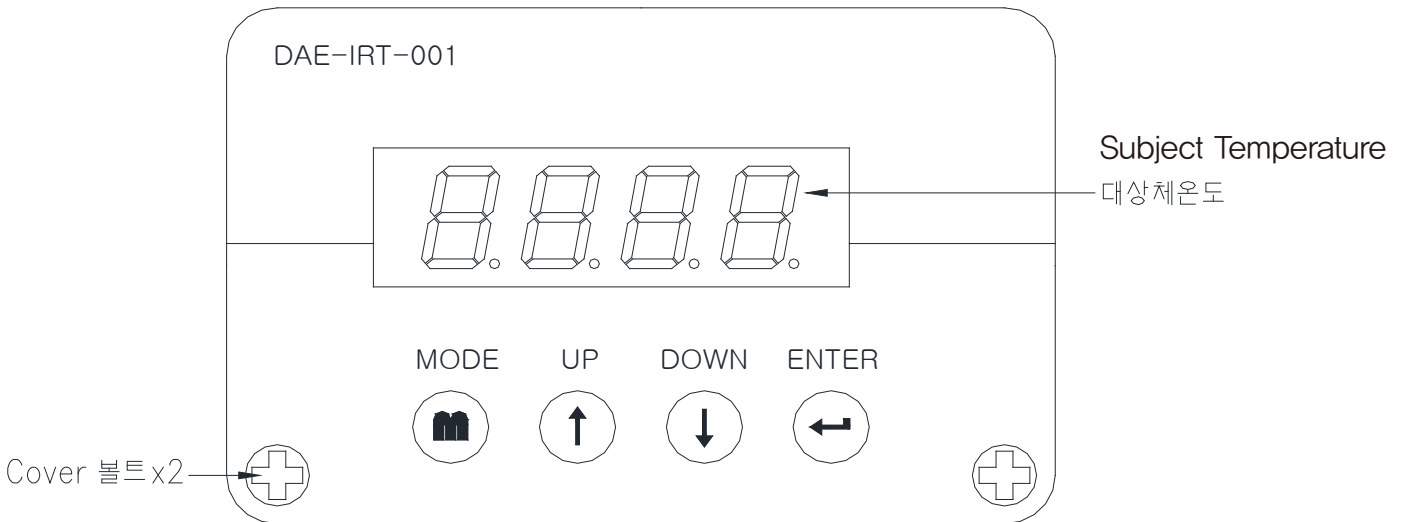

Name	Description
MODE	- Use upon entering into a setting mode. - Use upon moving to other menus in a setting menu.
UP	Use upon increasing a setting value in a measurement range (1 unit) ※ when a "UP" key is touched for longer than 5 seconds, the set value increases rapidly..
DOWN	Use upon decreasing a setting value in a measurement range (1 unit) ※ when a "DOWN" key is touched for longer than 5 seconds, the set value increases rapidly..
ENT	Use upon saving a setting value
UP+DOWN	Use upon entering a Measurement Mode from a Setting Mode

Menu Description

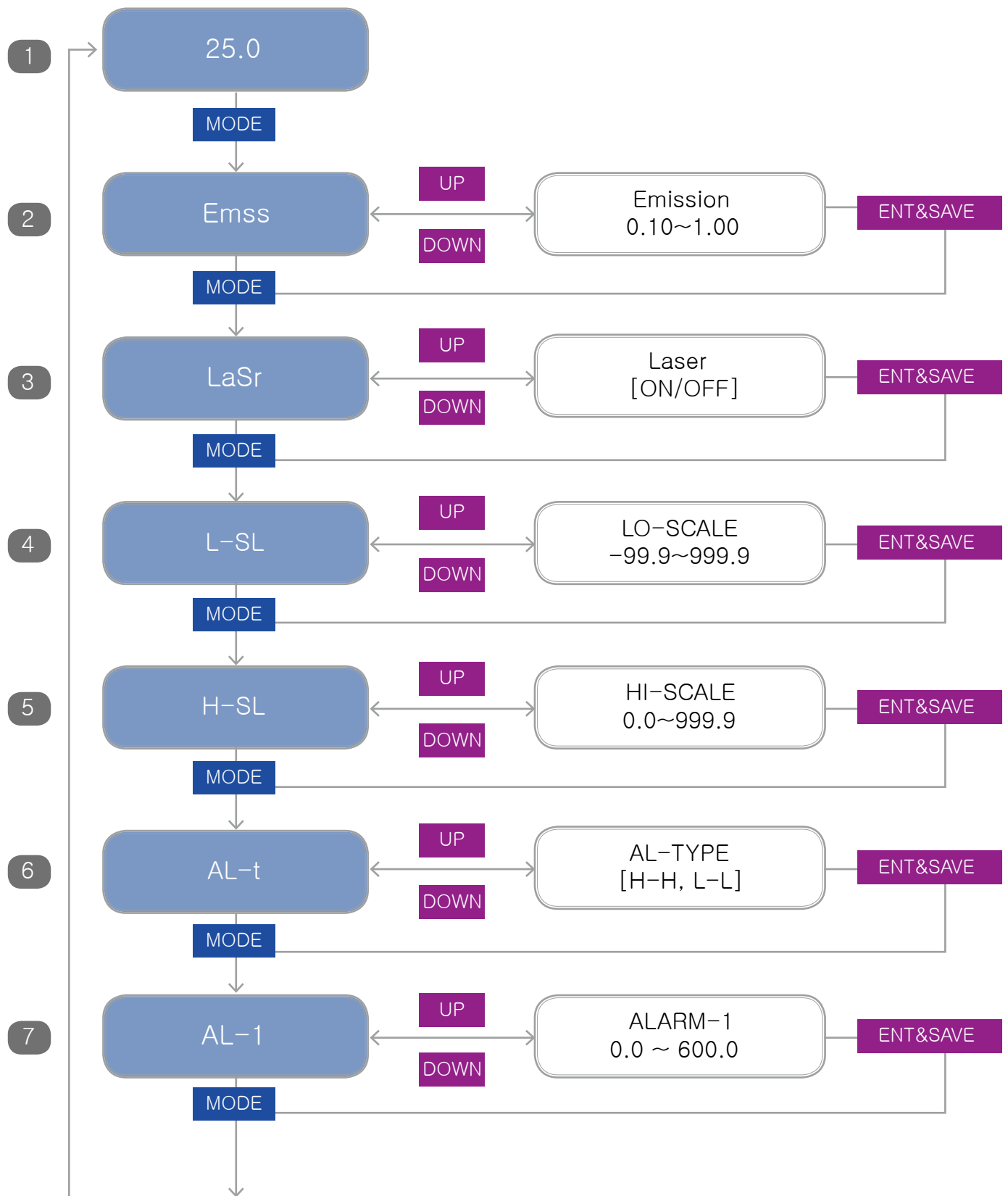

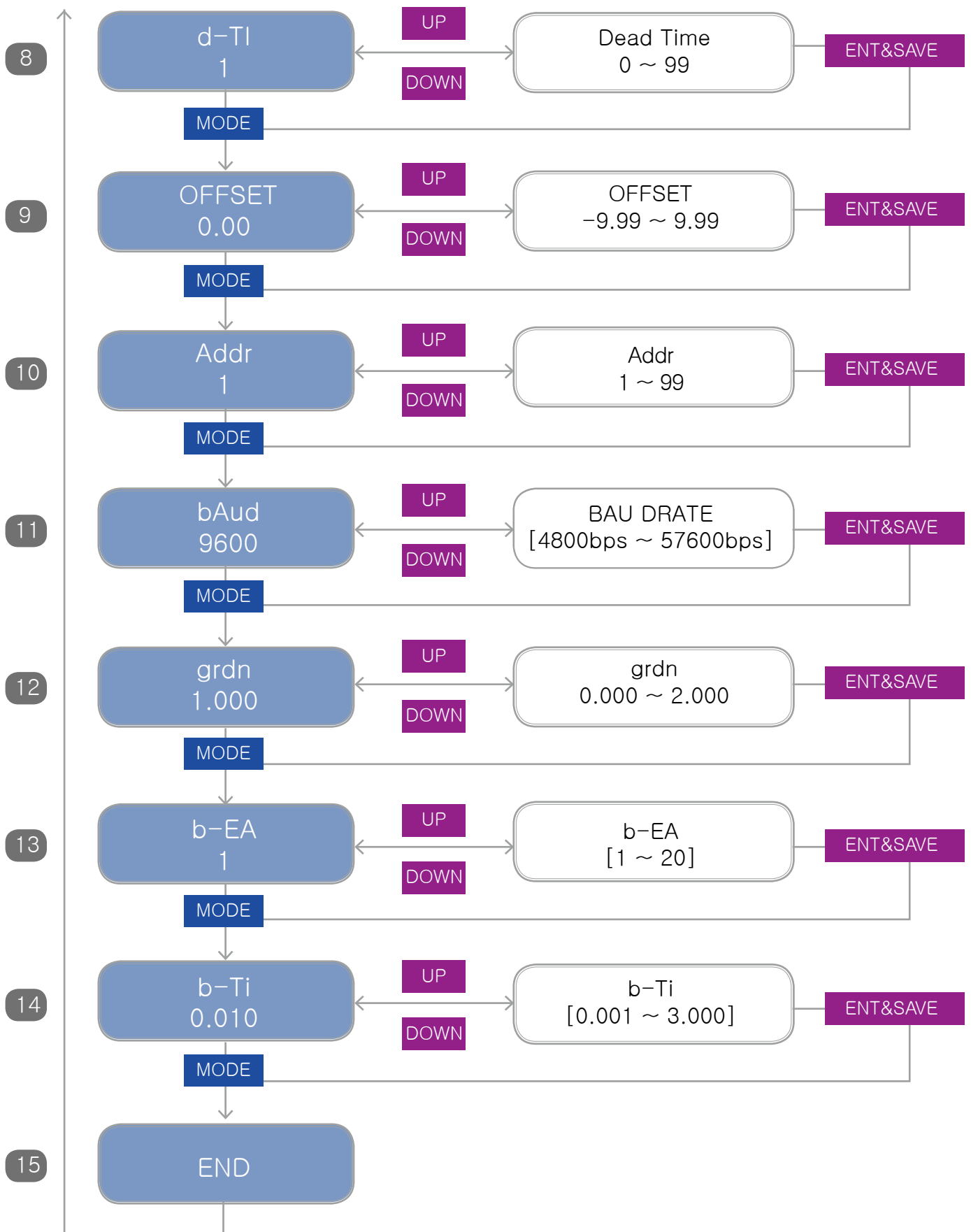

<1> Measurement Mode

- It measures object temperature and displays on FND.
Upon pressing MODE for 1 sec, it enters a setting mode

<2> Emission

- Menu to adjust the emissivity of the subject (Refer to a table of emissivity)

<3> Laser

- Activate the laser switch to aim the object.

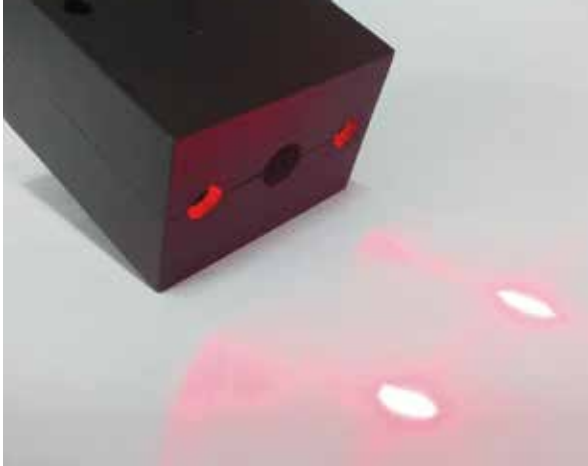

- Laser can be manually controlled in a menu mode and controlled in accordance with external input in a measurement mode.
- Menu mode: Laser ON / OFF control manually by pressing [UP], [DOWN] key in a LASER menu.
- Measurement Mode:

SW-G Terminal 0V Connection: Laser ON

SW-G Terminal OPEN: Laser OFF

<4> LO-SCALE

- Set up 4mA for FULL SCALE

<5> HI-SCALE

- Set up 20mA for FULL SCALE

(ex) When HI-SCALE is set up as 100.0

4mA analog output	-----	0.0	Display.
12mA analog output	-----	50.0	Display.
20mA analog output	-----	100.0	Display

<6> AL-TYPE(ALARM-TYPE)

- 2 types of set-up (H-H, L-L)
- ALARM Relay can be available on ALARM-1
ex) L-L Set-up
ALARM-1: LOW ALARM (Activate lower than the set-up value)

<7> ALARM-1

- ALARM-1 outputs Alarm Relay
(LOW & HIGH Alarm will be activated based on the set-up on ALARM TYPE)

<8> AL-TIME(ALARM TIME)

- This function is used to prevent from instantaneous malfunction, caused by external impact or noise, upon controlling over the output of ALARM-1.

<9> OFFSET (Measurement correction)

- Correct the error of the measurement value by adding or subtracting, which is generated by the detection unit,

ex) OFFSET: Set up -5.00

If the output error at the sensing unit is +5.00, the actual display will indicate +5.00

Correct OFFSET by -5.00 to make display 0.00

<10> ADDRESS

- Set up RS-485

<11> BAUDRATE

- Set up Baud rate of RS-485

<12> GRDN

- Accurate temperature setting by gradient correction against the measurement temperature error

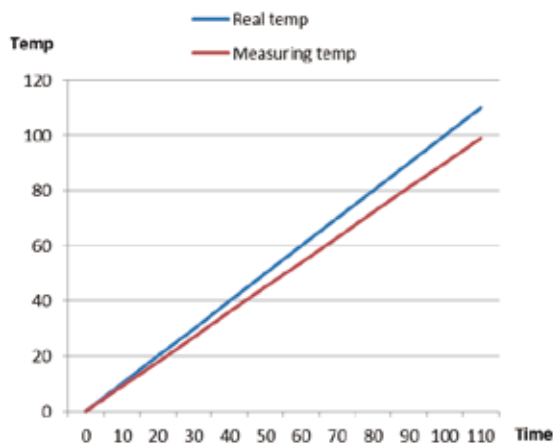

< Difference between actual temperature and measurement temperature >

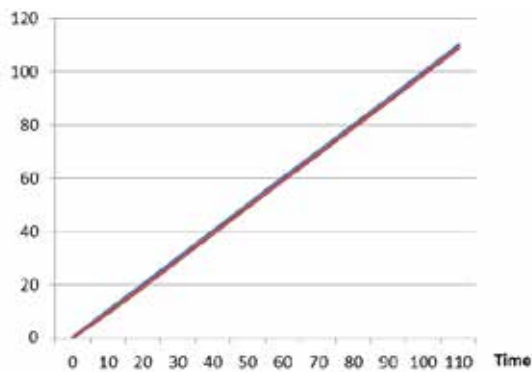

< The result of gradient correction for actual temperature and measurement temperature >

<13> b-EA (Number of Sample Buffer)

- Users can use within 1~20.
- Calculation of Average value per a number of sampling buffers
- ex) Average Temperature=(50.0+50.2+50.4+50.6)/4=50.3

4 Samples	50.0	50.2	50.4	50.6
-----------	------	------	------	------

<14> b_Ti(Sampling Delayed Time)

- User can use within 0.000 ~ 3.000 sec

ex)

- Set up 0.001 sec → Temperature Sampling per 1 msec
- Set up 0.010 sec → Temperature Sampling per 10 msec
- Set up 1.00 sec → Temperature Sampling per 100 msec

<15> END

- Enter a Measurement Mode

1. Communication Specification

- Communication ID: 1~99
- Baud Rate: 4800,9600,19200,38400,57600 bps
- 8 DATA BIT, 1 STOP BIT, NONE PARITY BIT
- STX:0x02, ETX:0x03, ACK:0x06, NAK:0x15
- BCC: Transmit XOR, from STX to ETX (Add 0x80 in case that value of BCC is less than 0x20)
- ID_H+ID_L: Communication address. [ex] 10(0x0a) → 0x30,0x3a
- CM: command
- PM: parameter
- HEX_4,HEX_3,HEX_2,HEX_1: 0x30~0x3F

1-1. Transmit to convert HEX code into ASCII

HEX	ASCII	HEX	ASCII	HEX	ASCII	HEX	ASCII
0x0	0x30	0x4	0x34	0x8	0x38	0xc	0x3c
0x1	0x31	0x5	0x35	0x9	0x39	0xd	0x3d
0x2	0x32	0x6	0x36	0xa	0x3a	0xe	0x3e
0x3	0x33	0x7	0x37	0xb	0x3b	0xf	0x3f

(ex) 10015(0x271F) → HEX4:0x32, HEX3:0x37, HEX2:0x31, HEX1:0x3F

1-2. Communication type

Number	Contents	Remark
1	STX(0x02)	Beginning Letters
2	ID HIGH	Upper-value number
3	ID LOW	Lower-value number
4	COMMAND(CM)	Command
5	PARAMETER(PM)	Parameter
6	DATA 4	DATA 4
7	DATA 3	DATA 3
8	DATA 2	DATA 2
9	DATA 1	DATA 1
10	ETX(0x03)	Final Letters
11	BCC	CHECK SUM

2. Basic Format for Communication

2-1. Read setting value (% Note: + sign is a delimiter and communication is not transmitted)

[Request]

STX+HD_H+HD_L+CM+PM+ETX+BCC

[Reply]

STX+HD_H+HD_L+CM+PM+HEX_4+HEX_3+HEX_2+HEX_1+ETX+BCC

2-2. Write Setting Value

[Request]

STX+HD_H+HD_L+CM+PM+HEX_4+HEX_3+HEX_2+HEX_1+ETX+BCC

[Reply]

ACK[NAK]

2-3. COMMAND

Command	Contents	Remark
R	Command for reading setting value	
W	Command for writing setting value	

2-4. Parameter

Command	Parameter	Contents	Model
R	'0'	Read Temperature (-60.0 ~ 380)	
	'1'	Read ambient temperature	
	'2'	Read emissivity	
	'F'	Read correction	
	'G'	Read gradient	

Command	Parameter	Contents	Model
W	'0'	Reserve	
	'1'	Reserve	
	'2'	Write emissivity	
	'F'	Write correction	
	'G'	Write gradient	

3. Protocol

3-1. Read Setting Value (% Note: + sign is a delimiter and communication is not transmitted)

〈1〉 Read Temperature

STX+ID_H+ID_L+'R'+0'+ETX+BCC → Request.

STX+ID_H+ID_L+'R'|0x80+0'+HEX_4+HEX_3+HEX_2+HEX_1+ETX+BCC ← Reply.

〈2〉 Read Ambien Temperature

STX+ID_H+ID_L+'R'+1'+ETX+BCC → Request.

STX+ID_H+ID_L+'R'|0x80+1'+HEX_4+HEX_3+HEX_2+HEX_1+ETX+BCC ← Reply.

〈3〉 Read Emissivity

STX+ID_H+ID_L+'R'+2'+ETX+BCC → Request.

STX+ID_H+ID_L+'R'|0x80+2'+HEX_4+HEX_3+HEX_2+HEX_1+ETX+BCC ← Reply.

〈4〉 Read Correction

STX+ID_H+ID_L+'R'+F'+ETX+BCC → Request.

STX+ID_H+ID_L+'R'|0x80+F'+HEX_4+HEX_3+HEX_2+HEX_1+ETX+BCC ← Reply.

〈5〉 Read Gradient

STX+ID_H+ID_L+'R'+G'+ETX+BCC → Request.

STX+ID_H+ID_L+'R'|0x80+G'+HEX_4+HEX_3+HEX_2+HEX_1+ETX+BCC ← Reply.

3-2. Read setting value in measurement range

Contents	Parameter	Measurement Range
Read Temperature	'0'	-60.0 ~ 380.0
Read Ambien Temperature	'1'	-60.0 ~ 150.0
Read Emissivity	'2'	0.10 ~ 1.00
Read Correction	'F'	-9.99 ~ 9.99
Gradient	'G'	0.000 ~ 2.000

Ex1) ID : 1 , Command for reading Temperature 25.0°C(250 = 0xFA)

0x02+0x30+0x31+'R'+0'+0x03+BCC → Request.

0x02+0x30+0x31+0xd2+0'+0x30+0x30+0x3F+0x3A+0x03+BCC ← Reply

Ex2) ID : 10 , Command for reading Temperature 2000.0°C(20000 = 0x4E20)

0x02+0x30+0x3A+'R'+0'+0x03+BCC → Request.

0x02+0x30+0x3A+0xd2+0'+0x34+0x3E+0x32+0x30+0x03+BCC ← Reply

Ex3) ID : 95 , Command for reading Temperature -30.0°C(300 = 0x12c)

→ 2' s complement (0x012c^0xffff)+1 → 0xFED4

(In case of minus number, applying to complement of 2 and send it)

0x02+0x35+0x3F+'R'+0'+0x03+BCC → Request.

0x02+0x35+0x3F+0xd2+0'+0x3F+0x3E+0x3D+0x34+0x03+BCC ← Reply

16bit Int Plus Number : 0x0 ~ 0x7FFF (0 ~ 32767)

16bit int Minus Number : 0xFFFF ~ 0x8000 (-1 ~ -32768)

3-3. Read Setting Value (% Note: + sign is a delimiter and communication is not transmitted)

〈1〉 Write Temperature

→ Reserve

〈2〉 Write Ambien Temperature

→ Reserve

〈3〉 Write Emissivity

STX++ID_H+ID_L+'W'+2'+HEX_4+HEX_3+HEX_2+HEX_1+ETX+BCC →
ACK[NAK] ←

〈4〉 Write Correction

STX++ID_H+ID_L+'W'+F'+HEX_4+HEX_3+HEX_2+HEX_1+ETX+BCC →
ACK[NAK] ←

〈5〉 Write Gradient

STX++ID_H+ID_L+'W'+G'+HEX_4+HEX_3+HEX_2+HEX_1+ETX+BCC →
ACK[NAK] ←

3-4. Write setting value

Contents	Parameter	Measurement Range
Reserve	'0'	
Reserve	'1'	
Write Emissivity	'2'	0.10 ~ 1.00
Write Correction	'F'	-9.99 ~ 9.99
Gradient	'G'	0.000 ~ 2.000

3-5. Detailed Description

Example 1) ID : No. 1 , Temperature 25.0, Reading Command (250 = 0xFA)

– Reading Temperature & Protocol Request

ID_H	ID_L	'R'	'0'	ETX	BCC
0x30	0x31	0x52	0x30	0x03	0x62

BCC: (0x02,0x30,0x31,0x52,0x30,0x03) Exclusive OR →

	Binary Number	Hexa decimal number
	0000 0010	0x02
	0011 0000	0x30
	0011 0001	0x31
	0101 0010	0x52
	0011 0000	0x30
	0000 0011	0x03
Exclusive OR	0110 0010	0x62

– Reading Temperature & Protocol Request

STX	ID_H	ID_L	R 0x80	'0'	HEX4	HEX3	HEX2	HEX1	ETX	BCC
0x02	0x30	0x31	0xd2	0x30	0x30	0x30	0x3f	0x3a	0x03	0xe6

BCC: (0x02,0x30,0x31,0xd2,0x30,0x30,0x30,0x3f,0x3a,0x03) Exclusive OR →

	Binary Number	Hexa decimal number
	0000 0010	0x02
	0011 0000	0x30
	0011 0001	0x31
	1101 0010	0xd2
	0011 0000	0x30
	0011 0000	0x30
	0011 0000	0x30
	0011 1111	0x3f
	0011 1010	0x3a
	0000 0011	0x03
Exclusive OR	1110 0110	0xe6

Emissivity Diagram (Original Specification)

Subject	Emissivity Value
Aluminum	0.05~0.25
Aluminum(Anodizing)	0.2~0.6
Chrome	0.25~0.3
Iron Oxide	0.4~0.95
Iron	0.1~0.5
Gold	0.02
Copper	0.06~0.2
Cooper Oxide	0.5~0.9
Magnesium	0.05~0.8
Brass	0.01~0.95
Oxidized Brass	0.65~0.75
Oxidized Nickel	0.4~0.9
White Gold	0.95
Silver	0.2~0.3
Molten Iron	0.85~0.95
Oxide Steel	0.8~0.90
Steel	0.3~0.45
Titanium	0.3~0.75
Oxidized Titanium	0.6~0.8
Zinc	0.4~0.6
Oxidized Zinc	0.5
Tin	0.1~0.3
Concrete	0.94
Cement	0.96

Installation Guide (Original Specification)

- Installation after checking the dimension on the measured subject

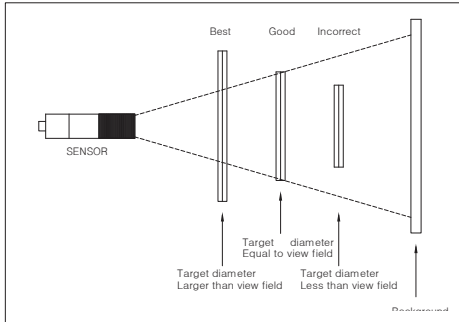

- The diameter of the measurement point is determined by the distance between the sensor and the Measured target.
- Referring to the optical chart, make the diameter of the measurement site smaller than the measured target.

- Blocking against thermal reflection of other measured subject at high temperature

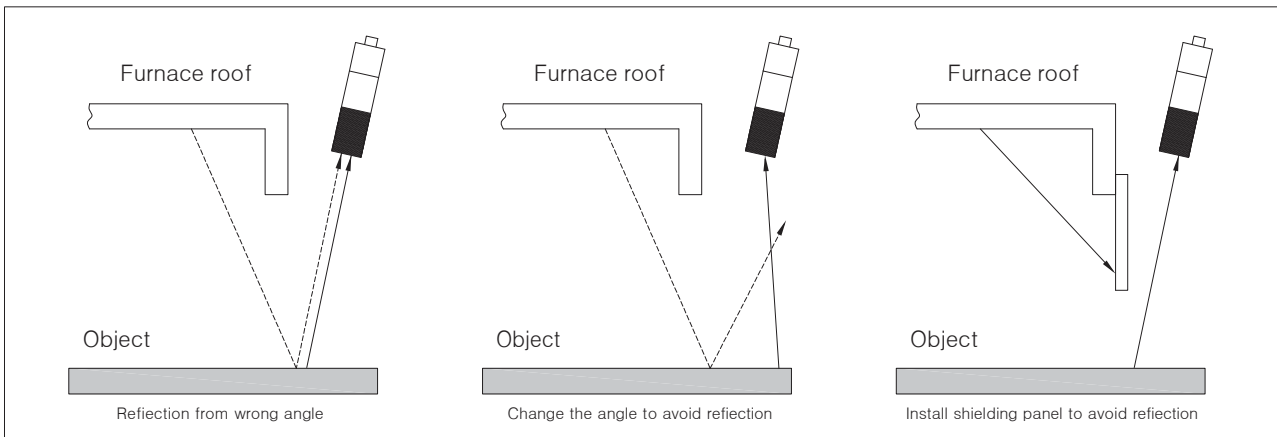

- Installation by blocking from strong light

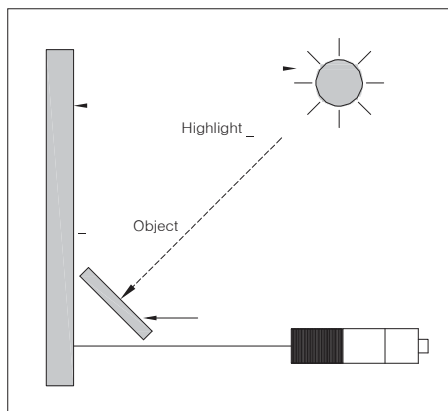

- Installation avoiding Electronic Noise.

Avoid high-frequency or high voltage installations. Ex) Motor, Pump, High-voltage cable area